



# The HERA ep Interaction Regions Learned Lessons

---

Uwe Schneekloth  
DESY

ENC/EIC Collider Workshop  
EINN09, Milos  
Sept. 2009



# Outline

---

- HERA Overview
- HERA I interaction region
- HERA II interaction region
- Detector Acceptance
- Background Conditions
- Vacuum System
- (Magnet Support and Alignment)
- Luminosity Measurement
- Forward and Rear Detectors
  
- Conclusions – Lessons
- General Remarks on ep Interaction Regions

# HERA Overview

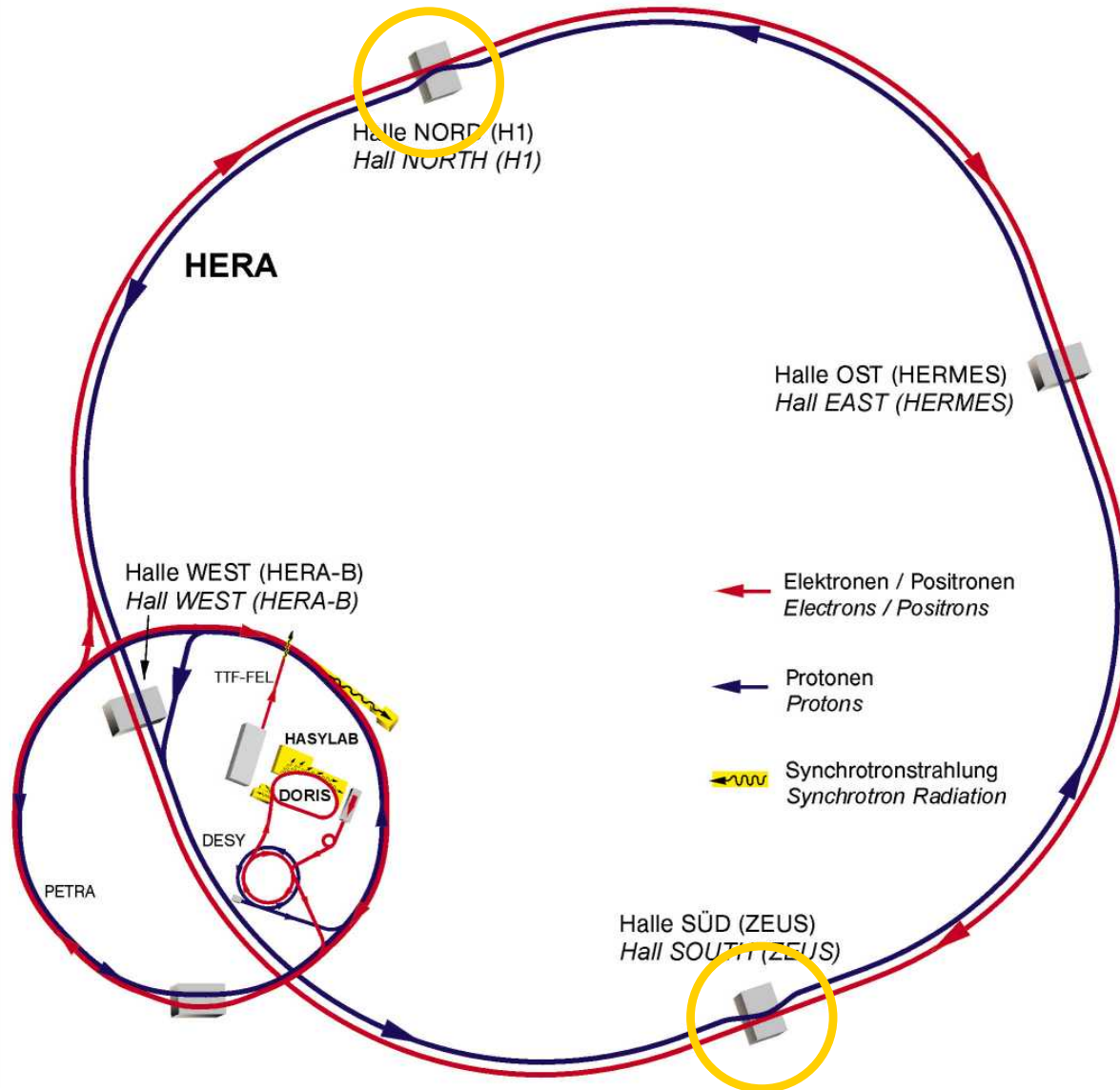

Electron (positron) -  
proton collider, in  
operation 1992 - 2007

Beam energies:

- protons 920 GeV
- electrons 27.6 GeV

180 bunches

96 ns bunch spacing

About 120m long straight  
sections (either side) for  
beam separation,  
focusing, acceleration,  
diagnostics and spin  
rotators

# HERA Operation

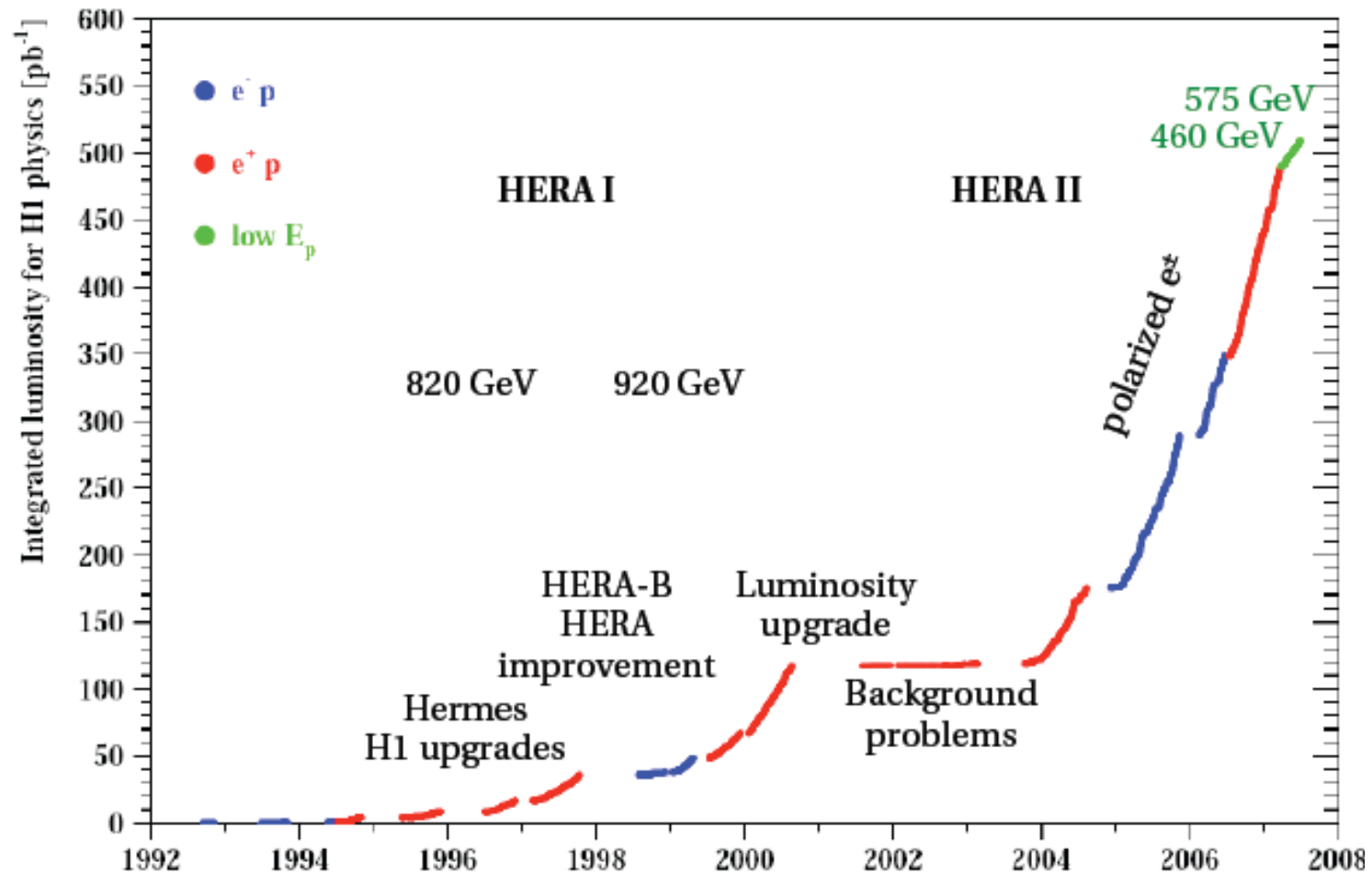

15 years of almost continuous beam operation



# IR Design Considerations

---

- Very asymmetric beam energies (920 on 27.6 GeV)
- High luminosity -> low beta quadrupole magnets close to IP, high gradients (different focusing magnets for p and e beam)
- Early beam separation -> use off-axis quadrupole magnets (combined focusing and beam separation)
- Sufficient beam aperture
- Electron and positron beams, with polarization
- Acceptable background conditions:
  - **synchrotron radiation and**
  - **particle background**
- Good detector acceptance
- Detector coverage down to small angles
- No “dead” material (machine elements) in front of detector components

# Sketch of e-p Interaction Region

HERA II

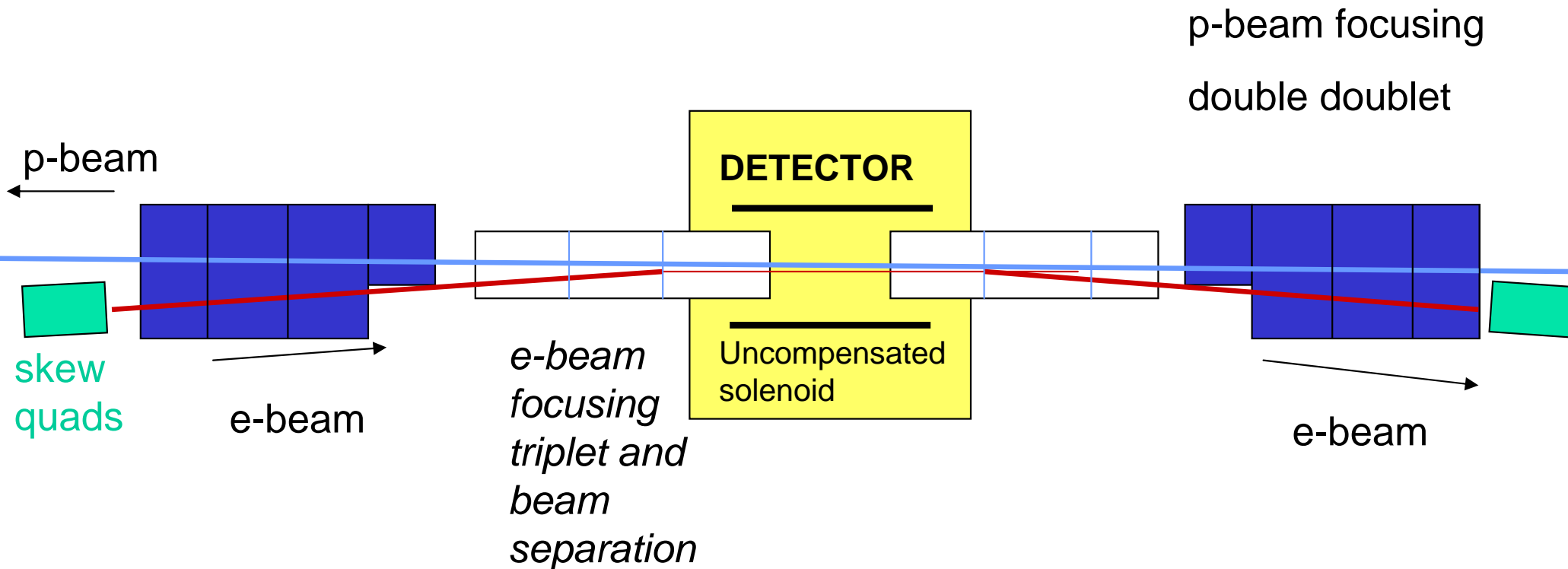

# e-p Luminosity Limitations

$$L = \frac{N_e N_p n_b f_{rev} R(\sigma_p, \beta_{x,y,e,p})}{2\pi \sqrt{\epsilon_{xp} \beta_{xp} + \epsilon_{xe} \beta_{xe}} \sqrt{\epsilon_{xp} \beta_{xp} + \epsilon_{xe} \beta_{xe}}}$$

$$\sigma_{x,y}^e = \sigma_{x,y}^p$$

Lepton beam current limited by RF power

Proton beam brightness limited by

- injector chain
- lepton bb effect
- intra-beam scatt.

$$L = \frac{\gamma_p N_p \cdot I_e \cdot R(\sigma, \beta)}{2\pi e \cdot \epsilon_N \sqrt{\beta_{yp}^* \cdot \beta_{xp}^*}}$$

Limited by IR design



# Luminosity Upgrade - HERA II

---

Increased luminosity by reducing beam size at IP

- Reduced beta functions of proton and electron beams at IP
- Reduced emittance of electron beam

Beta function

- Low beta quadrupole magnets as close as possible to IP
- Early beam separation
  - First magnet 1.7 m from IP (separation and focusing)
  - First proton quadrupole now at 11 m instead of 27 m from IP

Electron beam emittance

- Electron machine lattice stronger focusing
- Phase advance per cell increased from  $60^\circ$  to  $72^\circ$ .

Constraints

- Tried to keep good forward and backward coverage of calorimeters
- No upstream synchrotron radiation collimators anymore
- Had to remove compensating solenoids, added skew quads.



# HERA II Interaction Region

Half quadrupoles for p-focusing

Superconducting separators/quad's

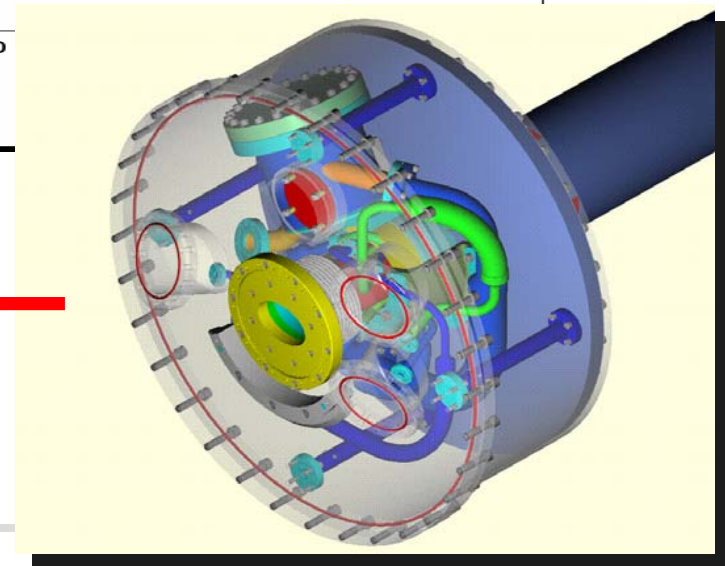
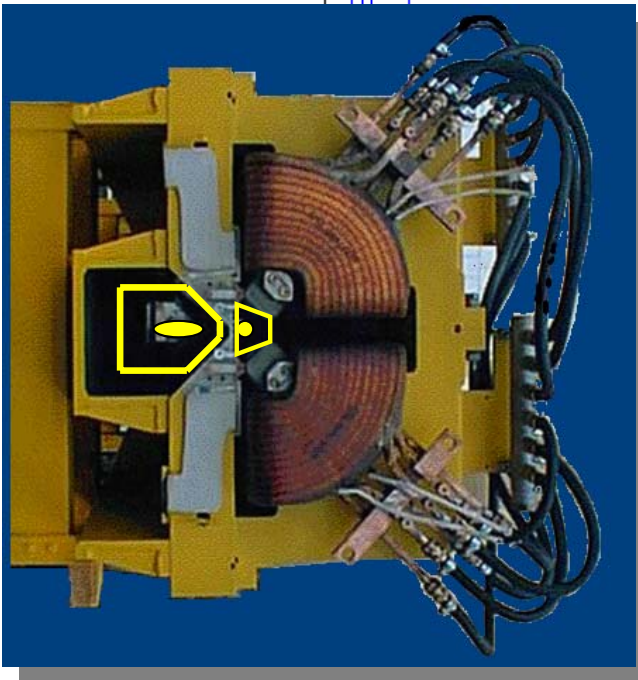
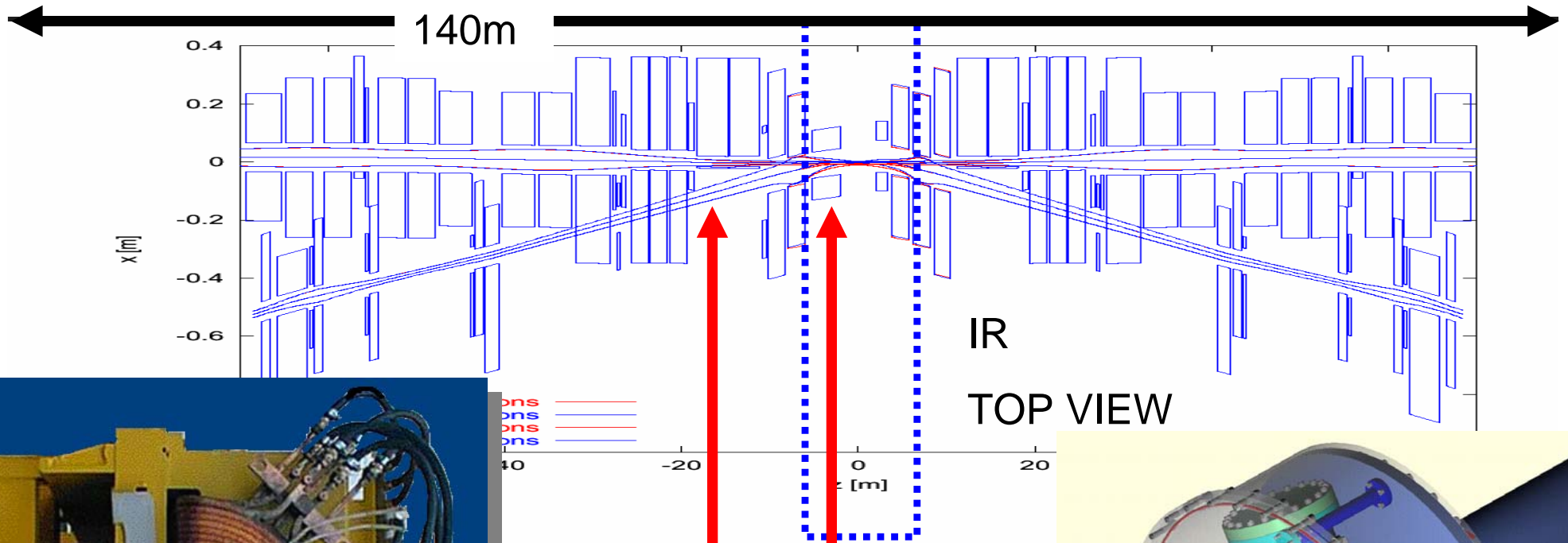

HERA Interaction Regions

# Comparison of HERA I/II Parameters

Parameter		HERA I design	HERA I 2000	HERA II design	HERA II achieved
Beam energy (GeV)	p e	820 30	920 27.5	920 30	920 27.5
Beam current (mA)	p e	140 58	100 50	140 58	100 45
Beam emit- tance(nm)	p-hor/vert e hor/vert	5.72/5.72 50/5	4.1/4.1 42/4	5.1/5.1 22/3.5	4.1/4.1 20/3
Beta function (m)	p-hor/vert e hor/vert	10/1 2/1	7/0.5 1.0/0.6	2.45/0.18 0.6/0.26	2.45/0.18 0.6/0.26
Beam size( $\mu\text{m}$ )	hor/vert	240/76	170/45	112/30	100/27
Aperture limit (sigma)	p-hor/vert e hor/vert	14/14 >30	12/10 >15	12/12 20	12/12 20
Beam-beam tuneshift	p-hor/vert e hor/vert	.0016/.00035 .02	.0019/.0003 .0161	.0033/.0005 .0291	.003/.0004 .0278
Luminosity	( $10^{31} \text{ cm}^{-1} \text{ s}^{-1}$ )	1.4	2.0	7.3	5.0

# ZEUS Detector - HERA I

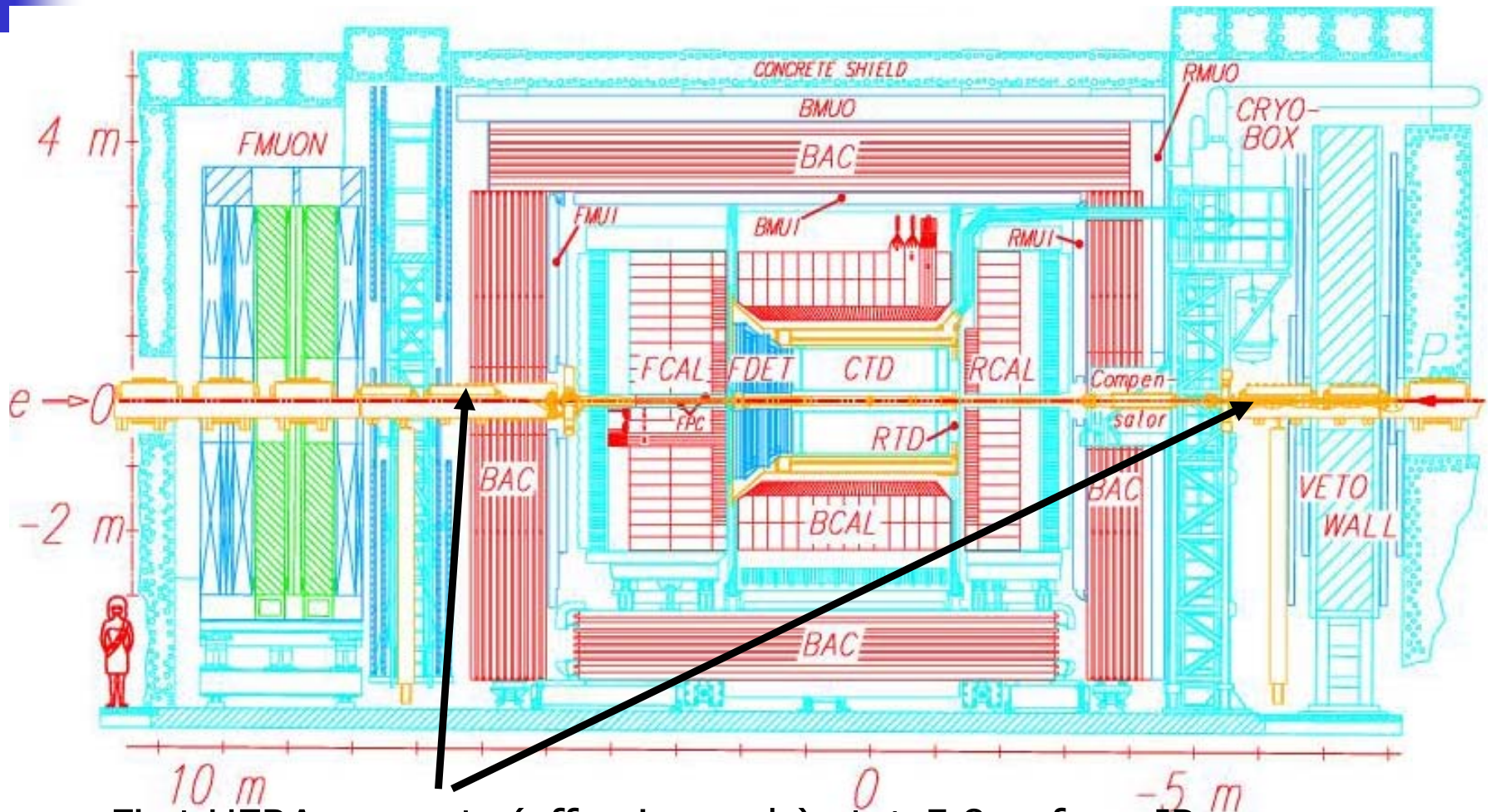

First HERA magnets (off-axis quads) at  $\pm 5.8$  m from IP

Calorimeter covers  $>99.8\%$  of full solid angle

Very small hole in FCAL (6.3 cm diameter), small vertical opening of RCAL

# ZEUS Detector - HERA II

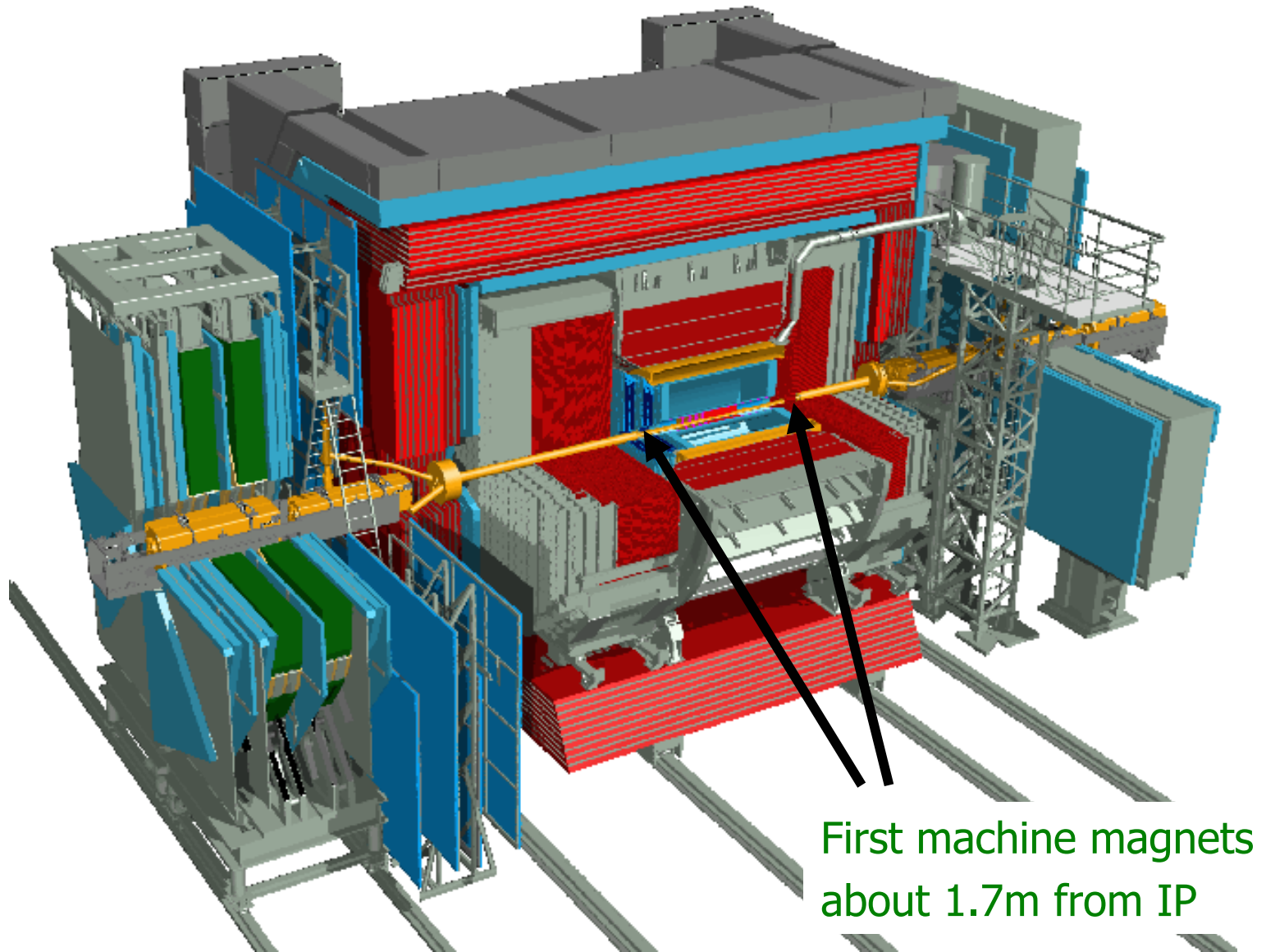

# HERA Magnets inside Detector



Inside ZEUS FCAL  
Low mass carbon  
fiber support

Inside H1 liquid argon  
calorimeter

GO magnet  
inside ZEUS

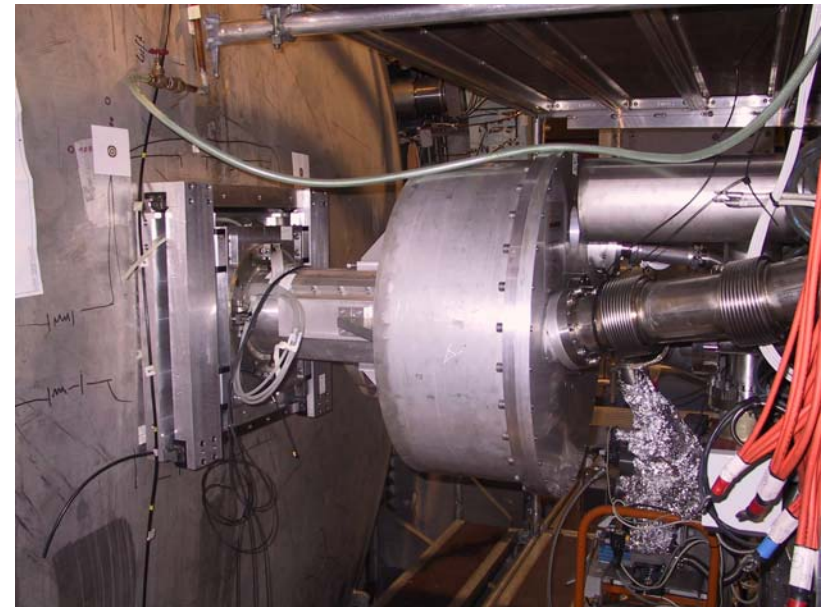
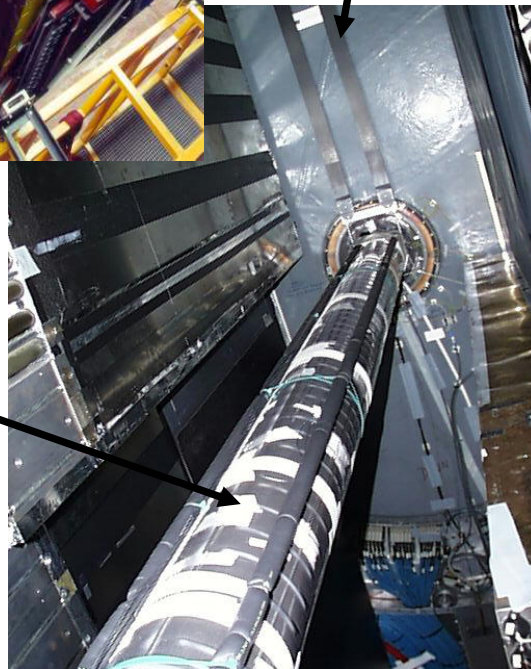

# Acceptance of Calorimeter (ZEUS)

Holes in calorimeter for beam pipe  
HERA I

- originally  $20 \times 20\text{cm}^2$ 
  - CAL covered 99.8% of full solid angle in forward hemisphere, 99.5% in rear hemisphere
- 1995 RCAL  $20 \times 8\text{cm}^2$  + beam pipe calorimeters (low x physics)
- 1997 FPC 6.3cm diameter (diffraction)

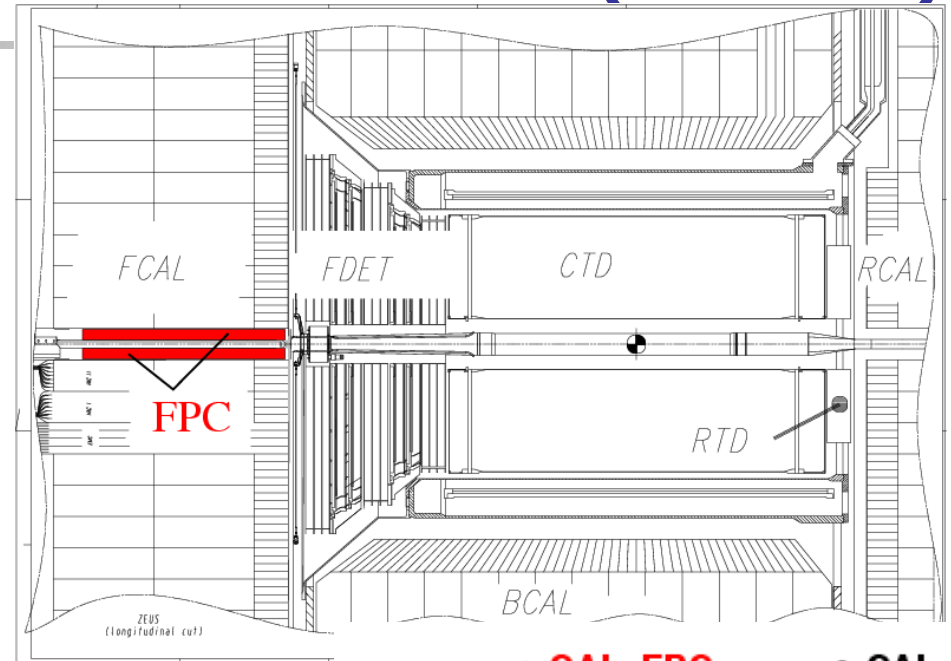

HERA II

- FCAL  $20 \times 20\text{cm}^2$
- RCAL  $20 \times 23.6\text{cm}^2$
- "Dead" material inside the detector volume (superconducting HERA magnets)

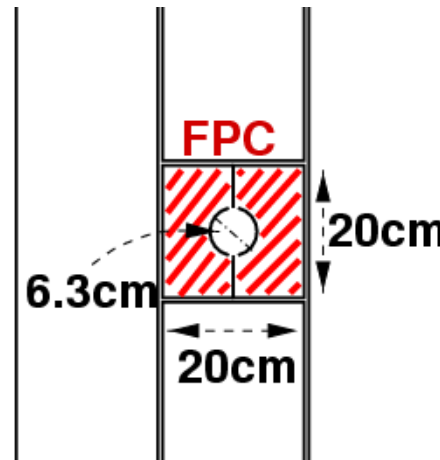

• CAL+FPC      ○ CAL  
 $Q^2 = 14 \text{ GeV}^2$

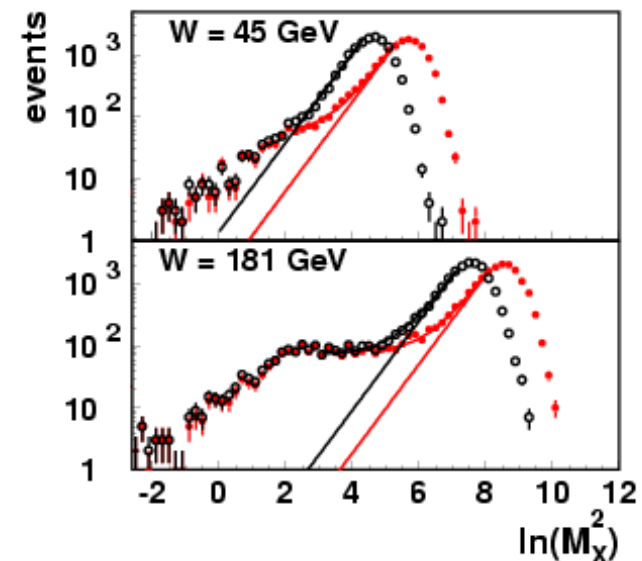

# HERA I: Acceptance Rear Calorimeter

Improved detection at very low angles (1995). Very low  $x$ ,  $Q^2$  physics.  
 Oval rear beam pipe with two thin exit windows to measure low angle electrons

- Top and bottom RCAL modules moved closer to beam (20  $\rightarrow$  8cm)
- Beam Pipe Calorimeter  
 Two small electromagnetic tungsten/scintillator calorimeters at  $z = -2.9\text{m}$

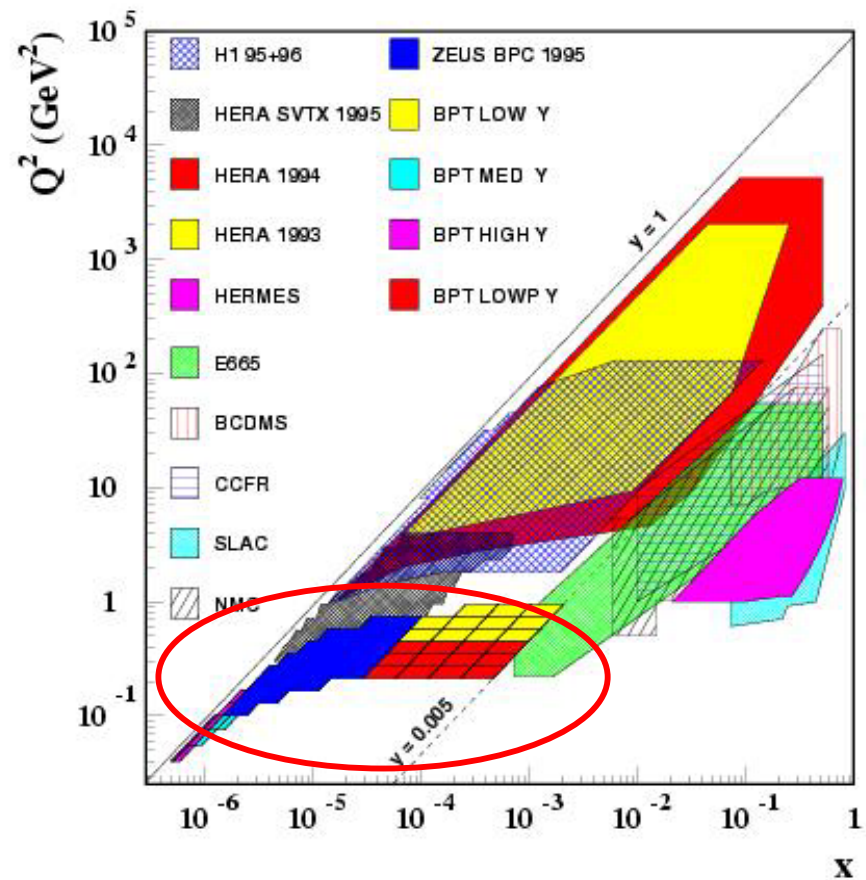
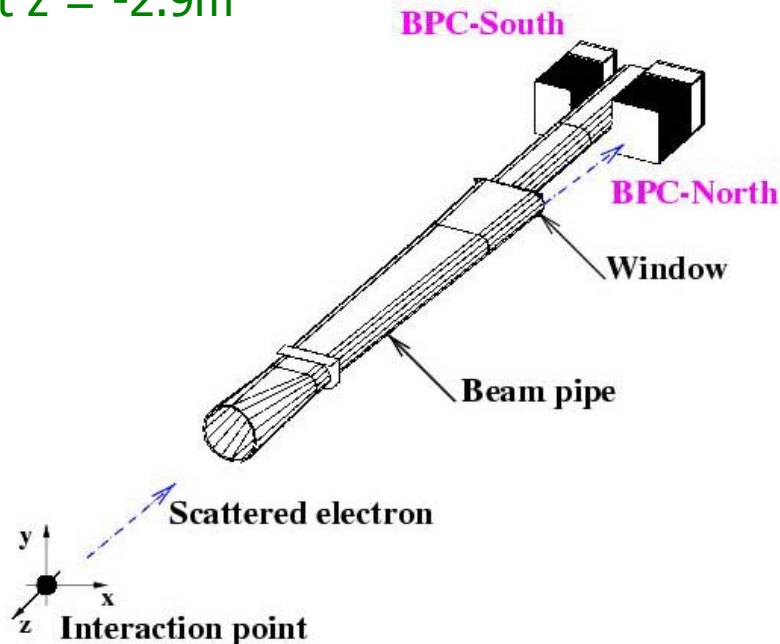



# Background Sources at HERA

---

## Electron/positron beam

- Synchrotron radiation
  - Backscattering
  - Photo desorption
    - > degradation of vacuum
- Beam gas interactions
  - Off-momentum electrons
- Higher order mode losses
  - Local heating at injection and ramp (short bunches)
    - > degradation of vacuum

## Need

- Careful design of interaction region and masks
- Excellent vacuum system

## Proton beam

- Low beam lifetime during injection and ramping
- Beam gas interactions, large hadronic cross section
  - Secondary interactions with aperture limitations, i.e. with magnets, beam pipe, masks
- Beam halo, coasting beam



# Synchrotron Radiation - HERA I

Total power 6 kW (original design 18.6 kW at 35 GeV)  
Critical energy 34 keV (original design 70 keV at 35 GeV)

- Detector shielded by 3 movable upstream collimators.
- Half of the SR power absorbed upstream
- No problem with tails
- Two fixed collimators near IP against back-scattering.
- Absorbers at 24/25m

In general, background conditions very low.

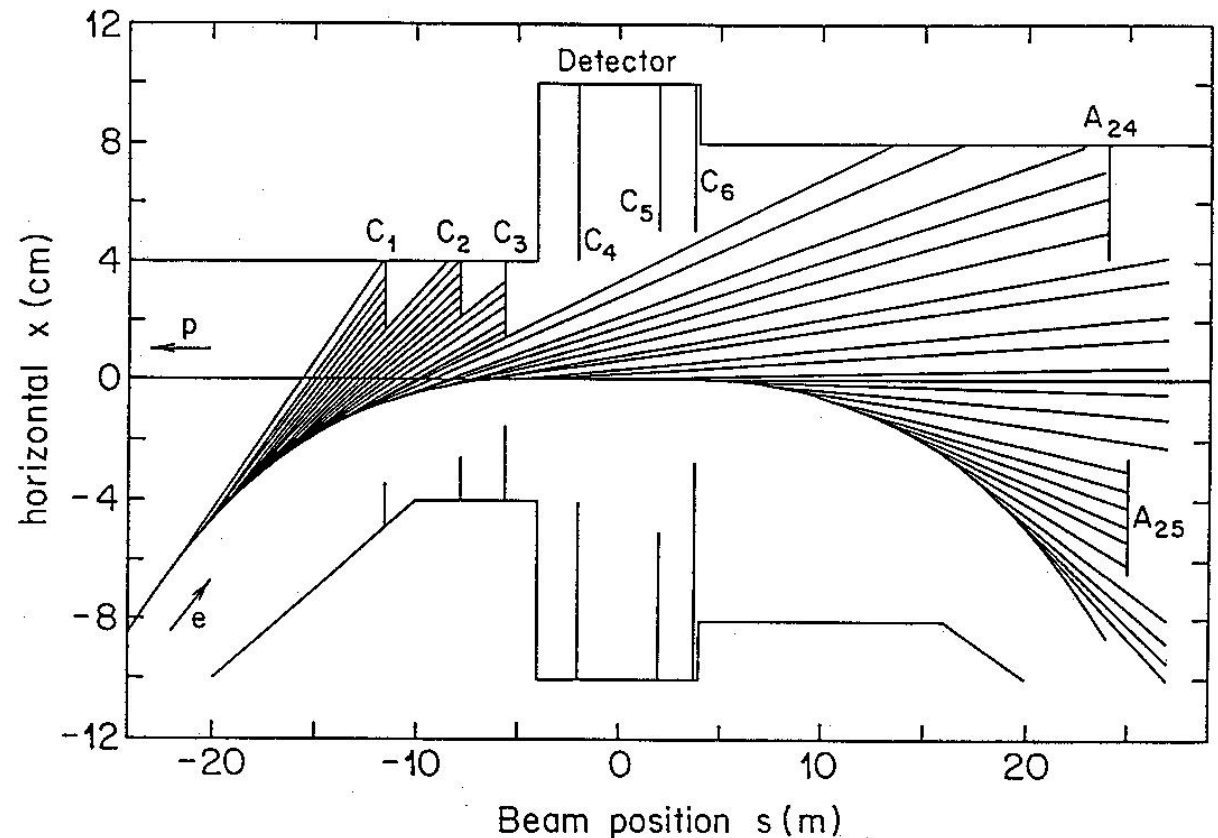

# Synchrotron Radiation - HERA II

- Total power 18kW (26kW at 30GeV)
- Critical energy up to 115 keV (150 keV at 30 GeV)
- “No” upstream collimators
- Radiation fan must pass through IR
- Tails potentially very dangerous (beam steering and stability important)
- Main background source: back-scattering from absorbers 11 to 27 m right of IP
- Small central elliptical beam pipe

Top view of interaction region

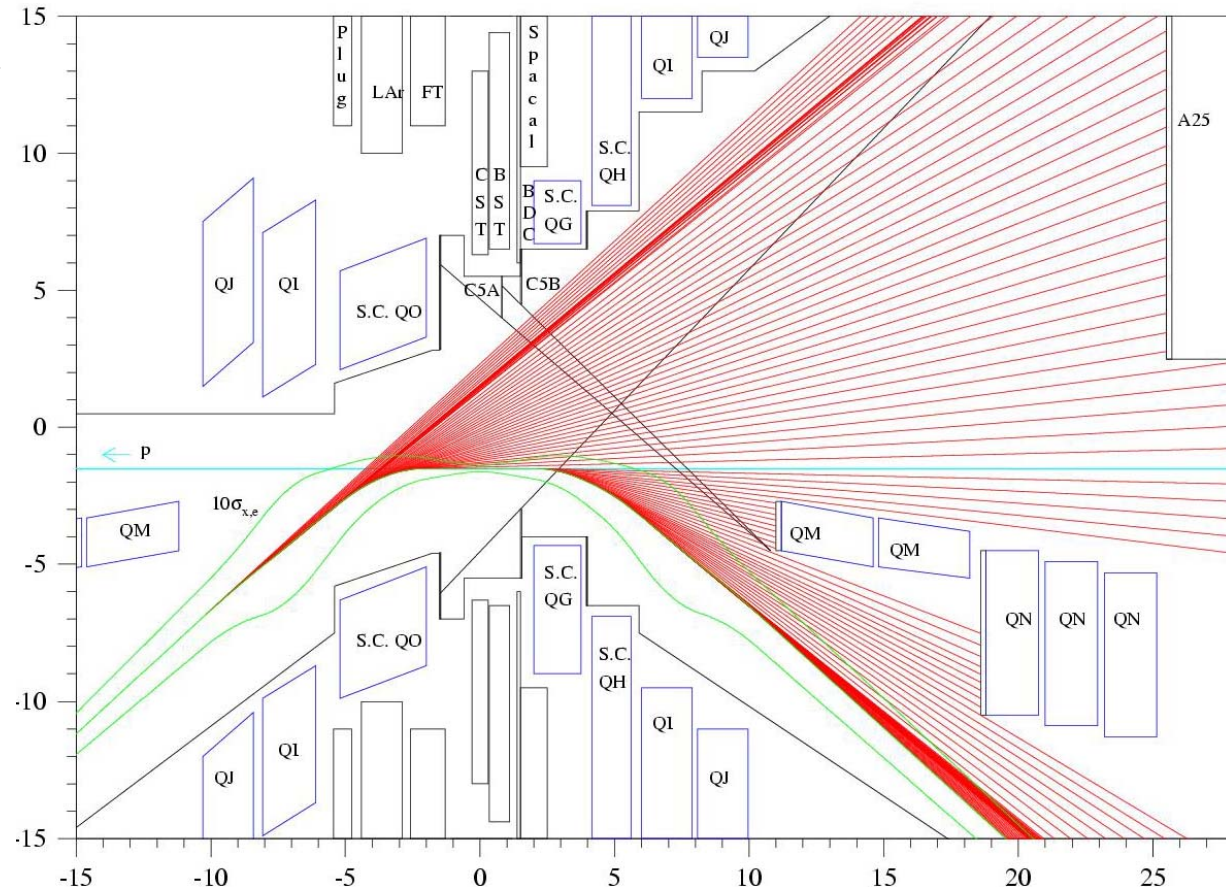



# Vacuum System

---

- Separate vacuum chambers (e, p and S.R.) starting at 11m from IP (location of synchrotron radiation absorber)
- As much pumping as possible:
  - All vacuum chambers equipped with integrated pumps if possible
  - Stainless steel chambers with NEG pumps above and below
  - Ion getter (60l/s) and Ti sublimation pumps between magnets
  - Integrated ion getter pump 1.3m from IP inside detector
- Stainless steel chambers protected by emergency absorbers
- Some special flanges due to lack of space
- In-situ bake-out not possible
- Super conducting magnet beam pipes at 40-80K
  - Had to be warmed up for regeneration of NEG pumps
  - Unfortunately, no valves between superconducting and warm magnets (NEG pumps) due to space constraints.

# Vacuum System

Pre-assembly in lab

Window  
for 6m  
tagger

Space for  
S.R. fan

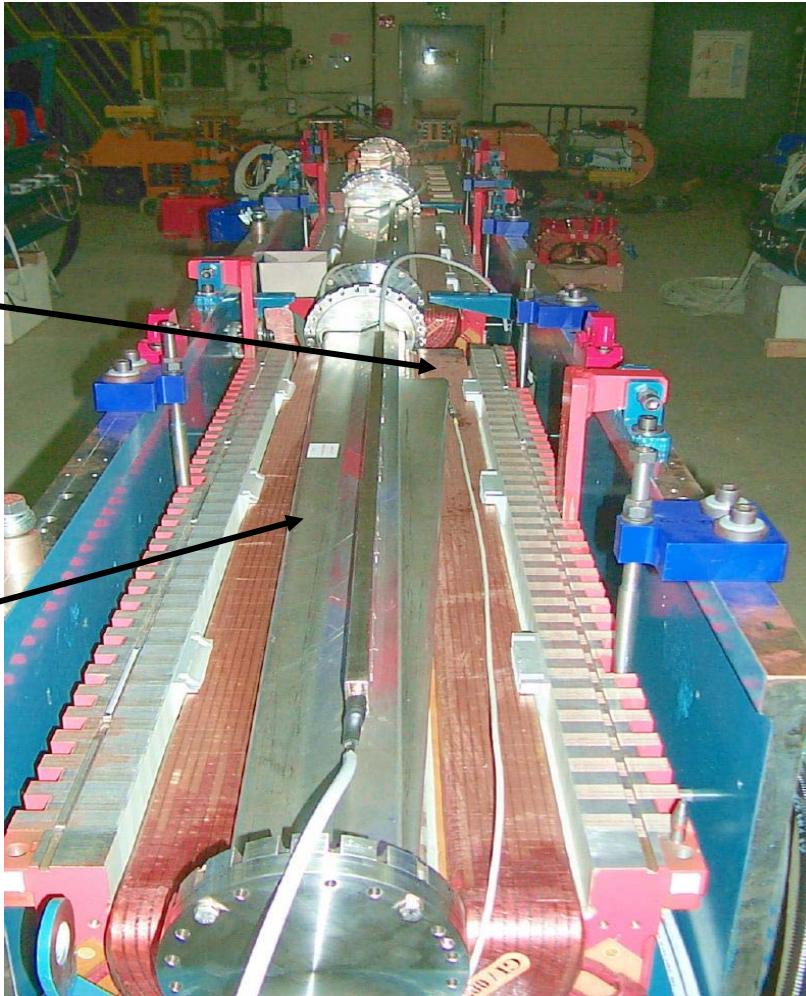

Need quite complicated vacuum chambers to accommodate e and p beams and synchrotron radiation fan

Ion getter pumps  
& Ti sublimation  
pumps

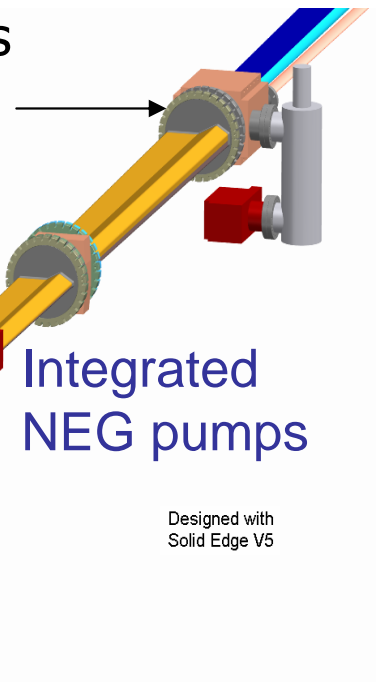

Integrated  
NEG pumps

Designed with  
Solid Edge V5



# HERA II Background Conditions

---

After recommissioning of HERA very severe background conditions. H1 and ZEUS could only turn on chamber HV at low currents. HERA beam currents limited in order to avoid radiation damage. Extensive background studies to understand and improve background conditions. Several month shutdown to implement improvements.

- **Proton beam-gas interactions most severe background**
  - Installed larger pumps at some critical locations, where possible
  - Increased conductance of pumping ports
  - Reduced HOM losses by improving shape of masks
  - Added integrated ion getter pump close to IP (H1)
  - Beam conditioning, slow vacuum improvement
- **Synchrotron radiation background**
  - Added far upstream synchrotron radiation collimator
  - Masks in IR improved (3D design problem) (ZEUS)
  - Improved alignment of HERA magnets
  - Better beam steering and control
- **Electron beam-gas (off-momentum positron)**
  - Additional pumps 30m upstream
  - Reduced thickness of synchrotron radiation mask

# Pressure during Luminosity Fill

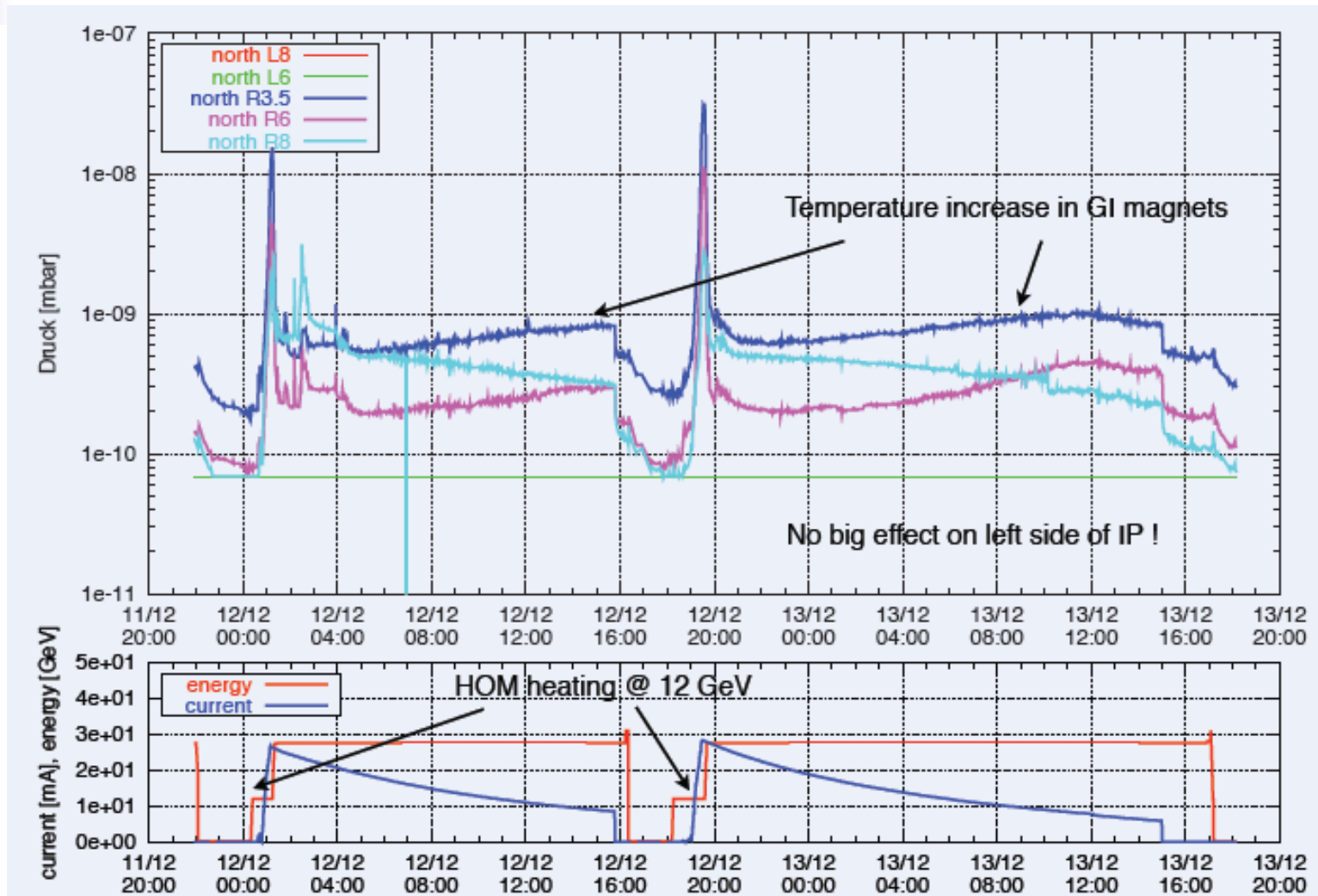

Dynamic pressure increase due to thermal and photo desorption

# Pressure Development

Pressure vs. integrated electron current 2002 - 03

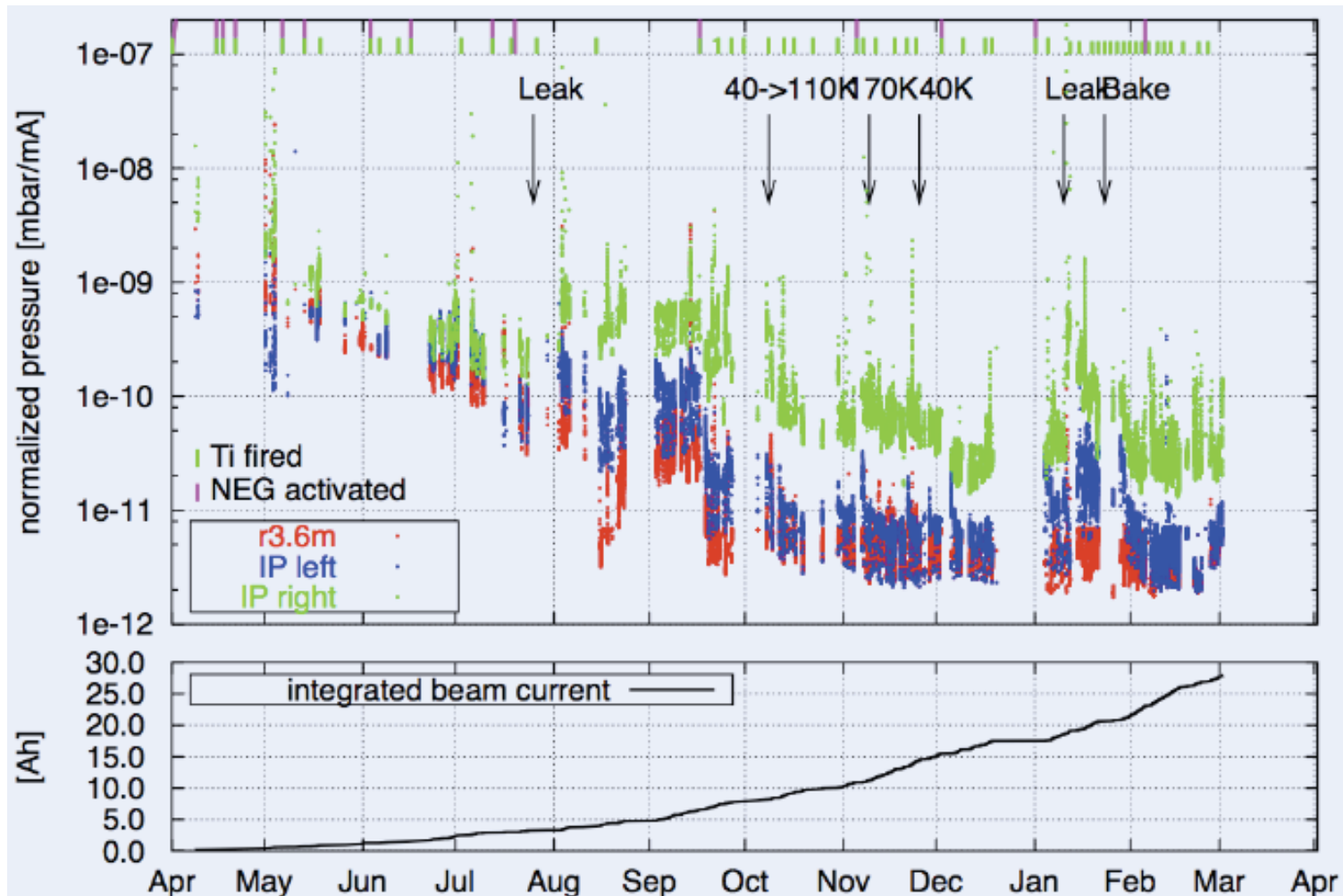

# Proton Beam Gas Background

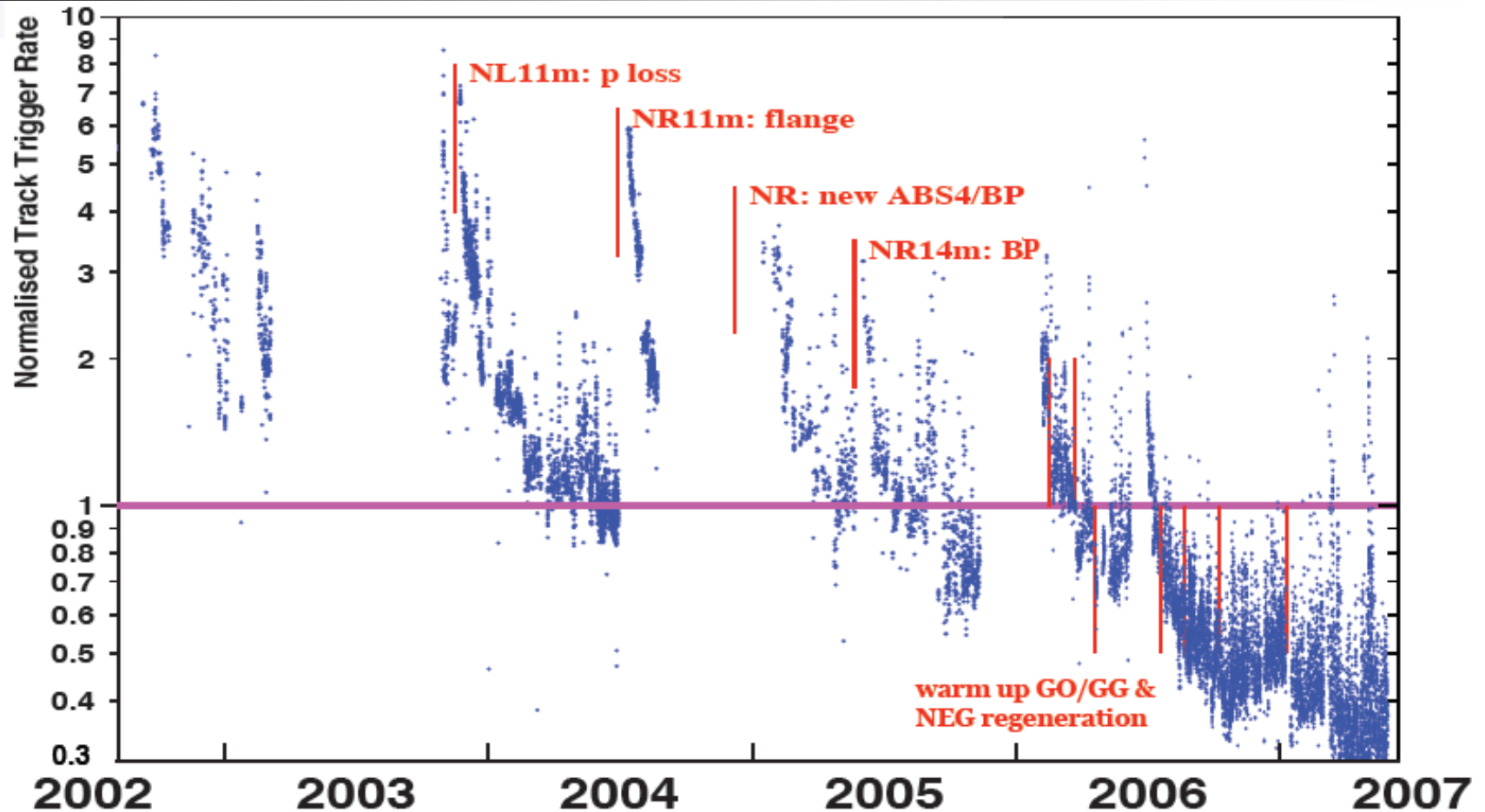

Two time constants for vacuum conditioning

- Short term after leaks 20 – 30 days
- Long term 600 days

Good vacuum needs patience and takes time. Continuous operation



# Vacuum Leaks

Several vacuum leaks occurred during operation

- Mis-steering of electron beam caused damage of vacuum chambers by S.R.. Aperture too tight.
- Some leaks at 11m absorber after high intensity electron beam loss
  - Thermal stress
  - Special flange too weak due to space limitations
  - Stainless steel chambers low thermal conductivity
- Vacuum chamber design of spin rotator section somewhat problematic
  - Heating due to synchrotron radiation

Improvements

- Active safety system based on temperature sensors and vacuum pressure readings. Input into electron beam dump.
- 11m absorber improved
- Orbit stabilizer for better orbit stability

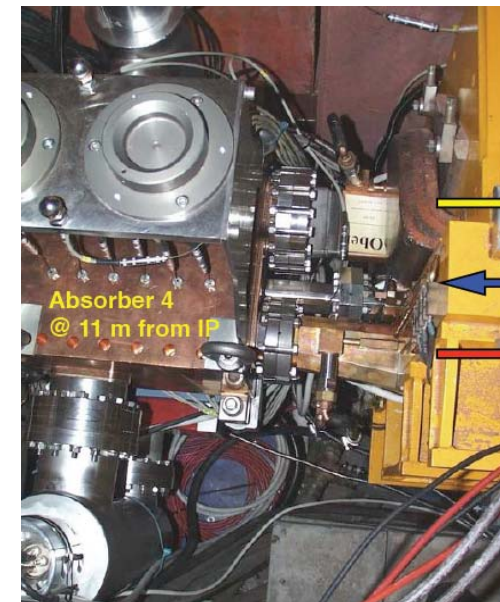
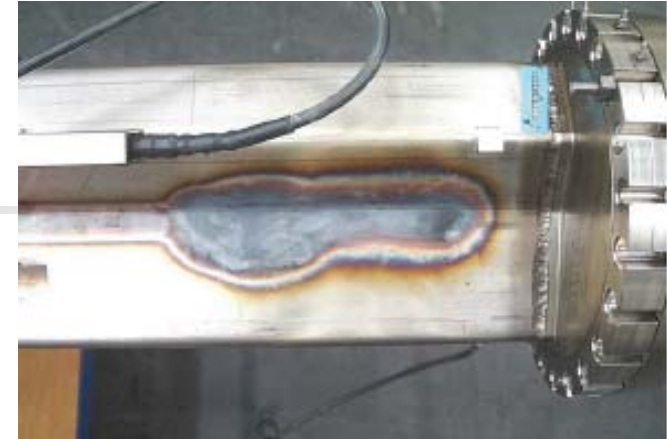

# Background Monitoring

## ZEUS Background Monitor

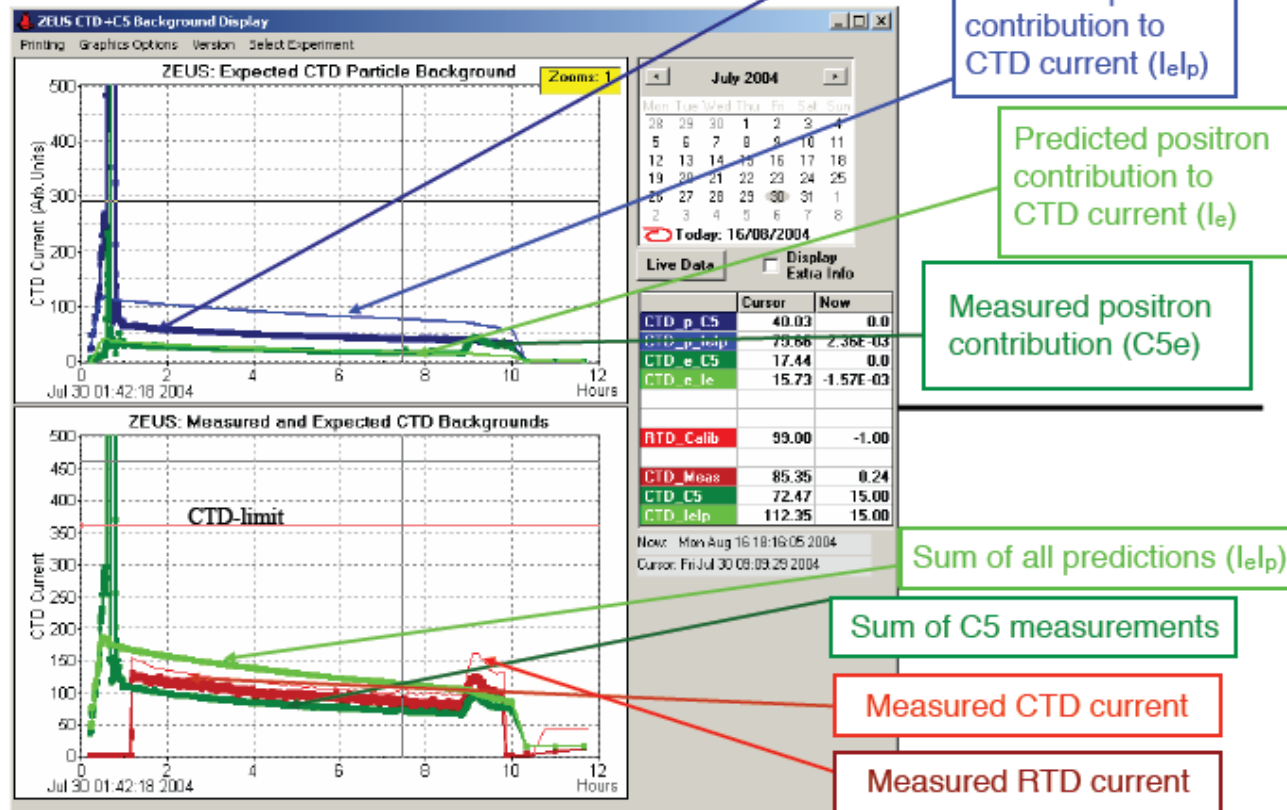

Comparison of actual and predicted background conditions

- Separated electron and proton backgrounds
- Very useful for beam steering and optimization



# Magnet Support and Alignment

---

- Support of final HERA magnets inside detector volume
  - GO/GG magnets low mass carbon fiber support at IP side
  - Remotely adjustable
  - Other magnets on girder (remotely adjustable)
- Alignment
  - Required alignment precision 0.3mm
  - Surveyed when detector open
  - GO/GG positions changed by up to 1mm when detector is closed
  - Wire alignment system (not fully functional)
  - Position sensors on magnets
  - GO/GG position changing when ZEUS calorimeter moving due to magnetic forces
    - Orbit stabilization procedure developed
  - Vertical position changing by 0.7mm during acceleration (H1)
    - Orbit feedback
  - Beam based alignment
    - Difficult: large beam offsets in quadrupole magnets
  - Magnets readjusted if necessary

Should have used stiffer supports for SC and warm magnets.



# Luminosity Measurement

Method: measure rate of bremsstrahlung process  $ep \rightarrow e' p \gamma$

Originally, measure coincidence of  $e'$  and  $\gamma$ .  $E_e = E_{e'} + E_\gamma$

Detectors in HERA tunnel:

- Photon detector 105m from IP at  $0^\circ$  (p beam is bent upwards)
- Electron detector 35m from IP (HERA magnets act as spectrometer)

$$L = 1 / \sigma_{BH}^{obs} \left[ R_{tot} - (I_{tot} / I_0) R_0 \right]$$

Bethe-Heitler cross section  $\sigma_{BH}^{obs} = A_\gamma \sigma_{BH}^{corr}$

Main background beam gas scattering:

Subtracted using pilot bunches

- bunch structure: p 180, e 194, colliding 174 (HERA I)

# Overview of Luminosity Monitor – HERA I

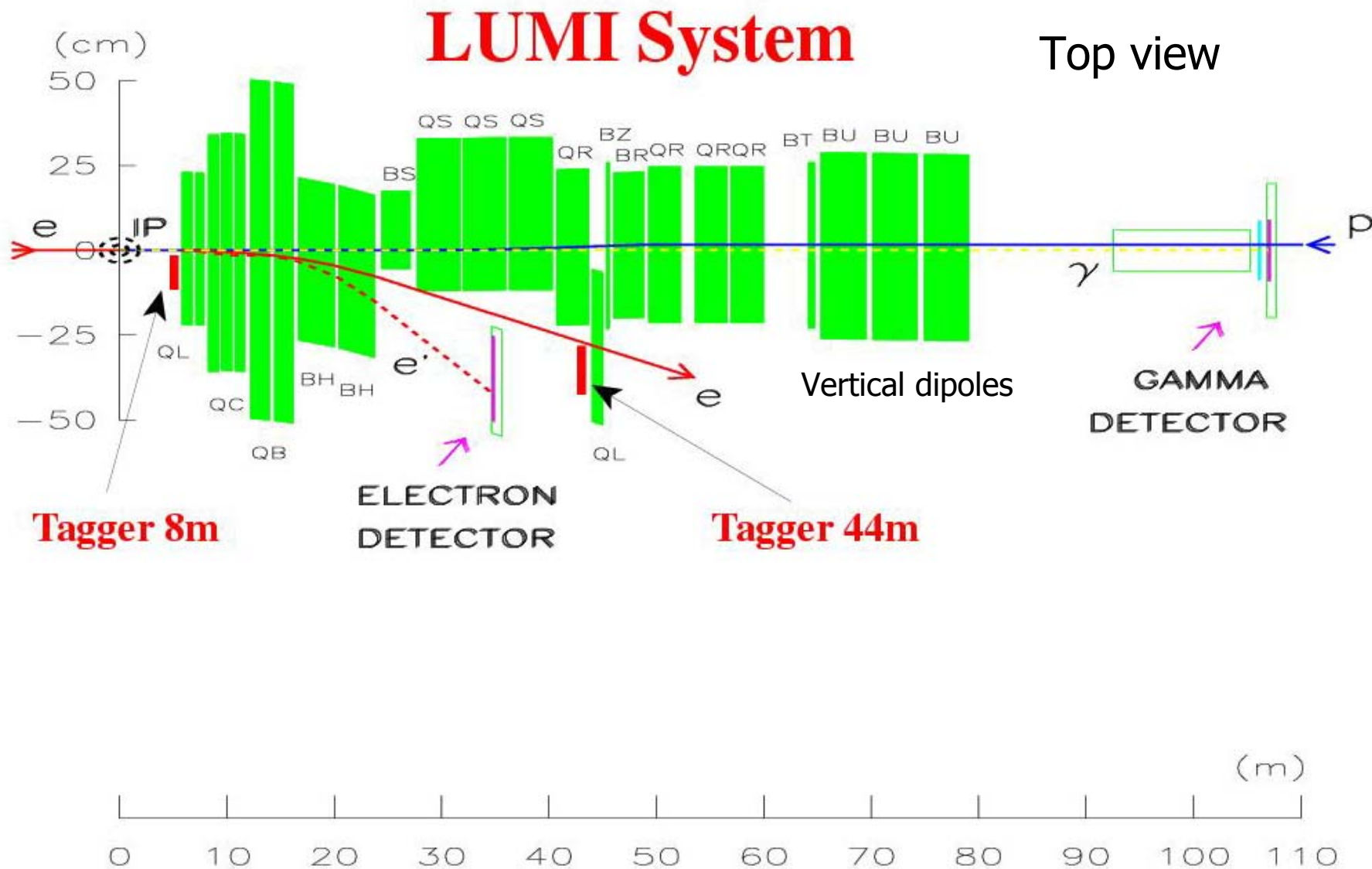

# Luminosity Measurement - HERA I

Synchrotron radiation requires filter in front of calorimeter

- Very good background conditions.
- Good photon acceptance.
- Electron acceptance more difficult
- Only using photon detector for luminosity measurement

Electron detector:

- systematic checks (calibration and acceptance)
- tag photo-production events
- estimate background of photo-production events in DIS

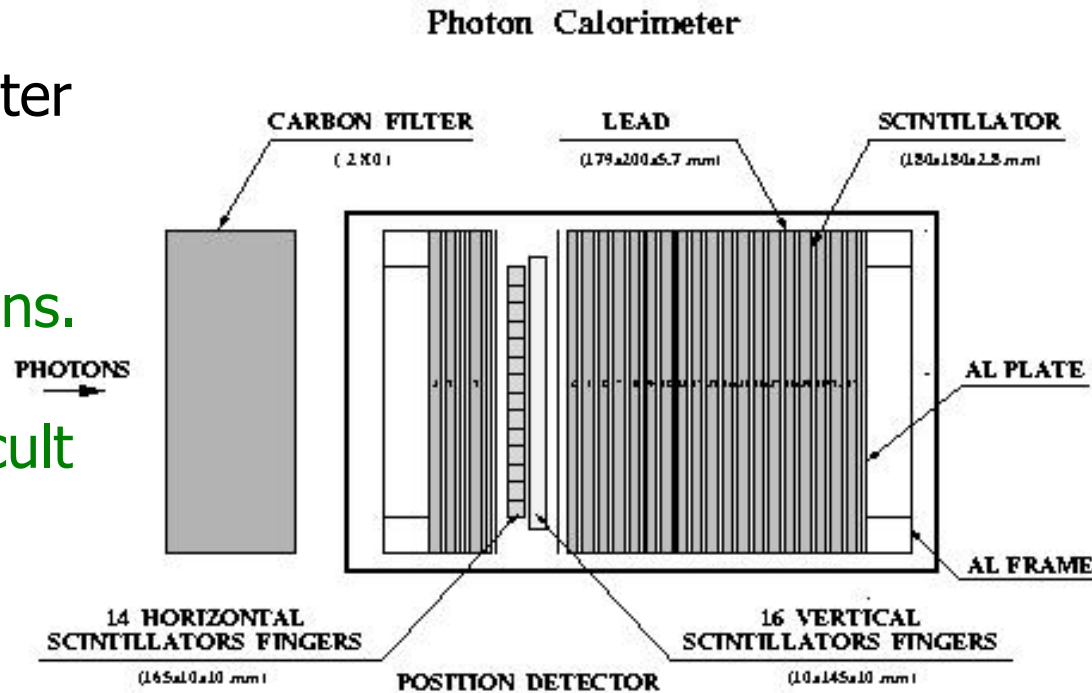

Typical systematic errors

Acceptance error	0.8%
Cross section calculation	0.5%
e gas background substr.	0.1%
Multiple event correction	0.03%
Energy scale error	0.5%
<b>Total error</b>	<b>1.05%</b>



# Luminosity Monitor Upgrade-HERA II

## Challenge

- Rate of bremsstrahlung photons increase by factor of 5
- Significant increase of synchrotron radiation hitting luminosity monitor
  - power in photon detector 400 → 1800 W
  - critical energy 35 → 150 keV
- Photon calorimeter would be damaged in a few months, expected dose O(Trad/year), need thicker filter in front.
- Somewhat slower acceptance due to larger beam divergence

## Upgrade (ZEUS)

- Build radiation hard calorimeter with increased filter thickness ( $4 X_0$ )
- Active filter
  - Cherenkov detectors only sensitive to charged particles
  - correct for energy loss in filter
- Electron - positron pair spectrometer
- Goal 1% luminosity measurement

# Luminosity Measurement HERA II

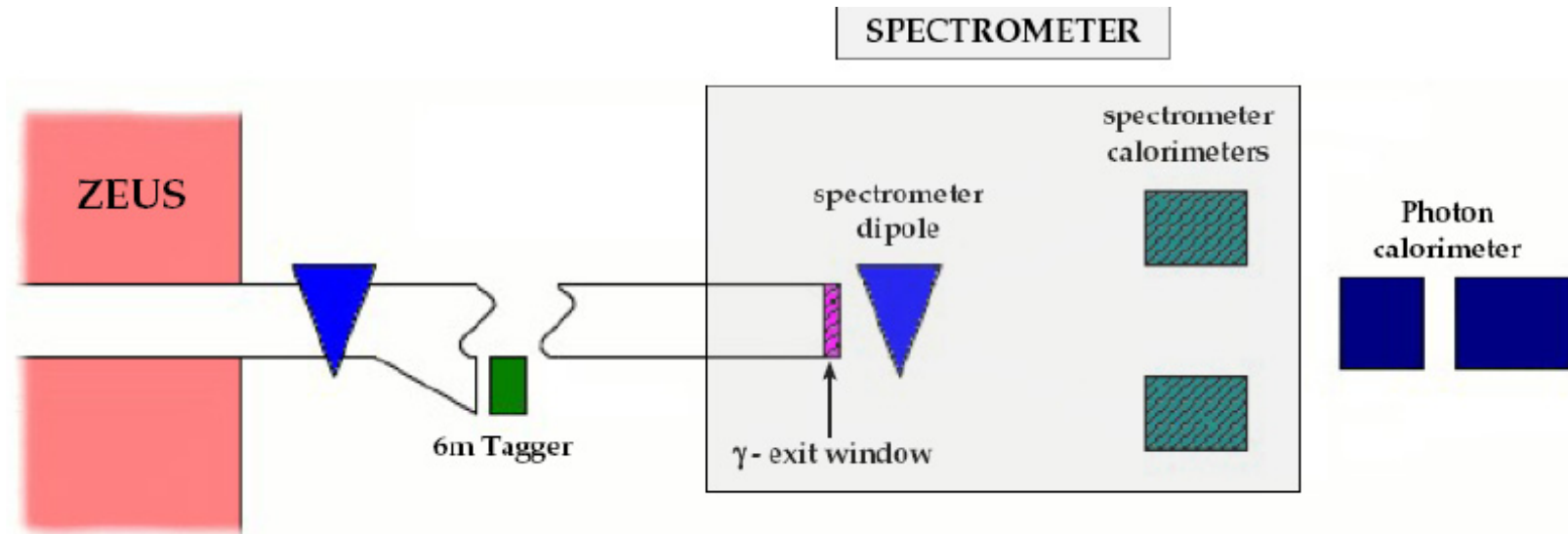

Spectrometer advantages:

- No synchrotron radiation
- No problem with radiation damage (at least in principle)
- No pile-up
- Independent and complementary luminosity measurement





# Luminosity Measurement HERA II

---

## Experience

- Luminosity measurement quite challenging
- Acceptance determination more difficult than expected (use of 6m tagger)
- Reduced acceptance due to larger beam divergence
- Photon CAL:
  - Cherenkov detector not really used. Position dependence. Still synchrotron radiation in first detector
  - Uncertainties in energy scale (small non-linearities)
- Spectrometer
  - Did suffer from radiation damage (back-scattered S.R.)
  - Some hardware instabilities
- 6m tagger
  - Suffered from radiation damage
  - Had to be rebuilt: corrosion due to leak in water cooling

Systematic error presently 2.5%. Progress towards 2%  
Two independent detectors/methods very useful.



# Rear Detectors

---

## HERA I

Several electromagnetic calorimeters for electron tagging and photon detections (H1 and ZEUS very similar)

Purpose: low  $x$  and  $Q^2$  physics, reject photoproduction bgrd in DIS, electron tagging for photoproduction,  $\sigma_{\text{tot}}$  measurement, calibration of luminosity monitor

- Beam pipe calorimeters/tracker at 2.9m
- 8m tagger 1 – 3 GeV
- 36m tagger 5 – 19 GeV
- 44m tagger (movable vacuum chamber) 21 – 26 GeV
- 105m photon calorimeter luminosity monitor

## HERA II

- Taggers at 6 and 40m
- H1 backward silicon tracker
  - Extension of central vertex detector
  - Important for  $F_L$  measurement



# Forward Detectors

---

- Forward plug calorimeter (HERA I)
  - improved acceptance of forward calorimeter
- Forward neutron calorimeter
  - Hadronic calorimeter (with tracker) at zero degree, 110m from IP
- Leading (forward) proton spectrometer
  - Set of proton position detectors in Roman pots moving close to proton beam

# ZEUS LPS

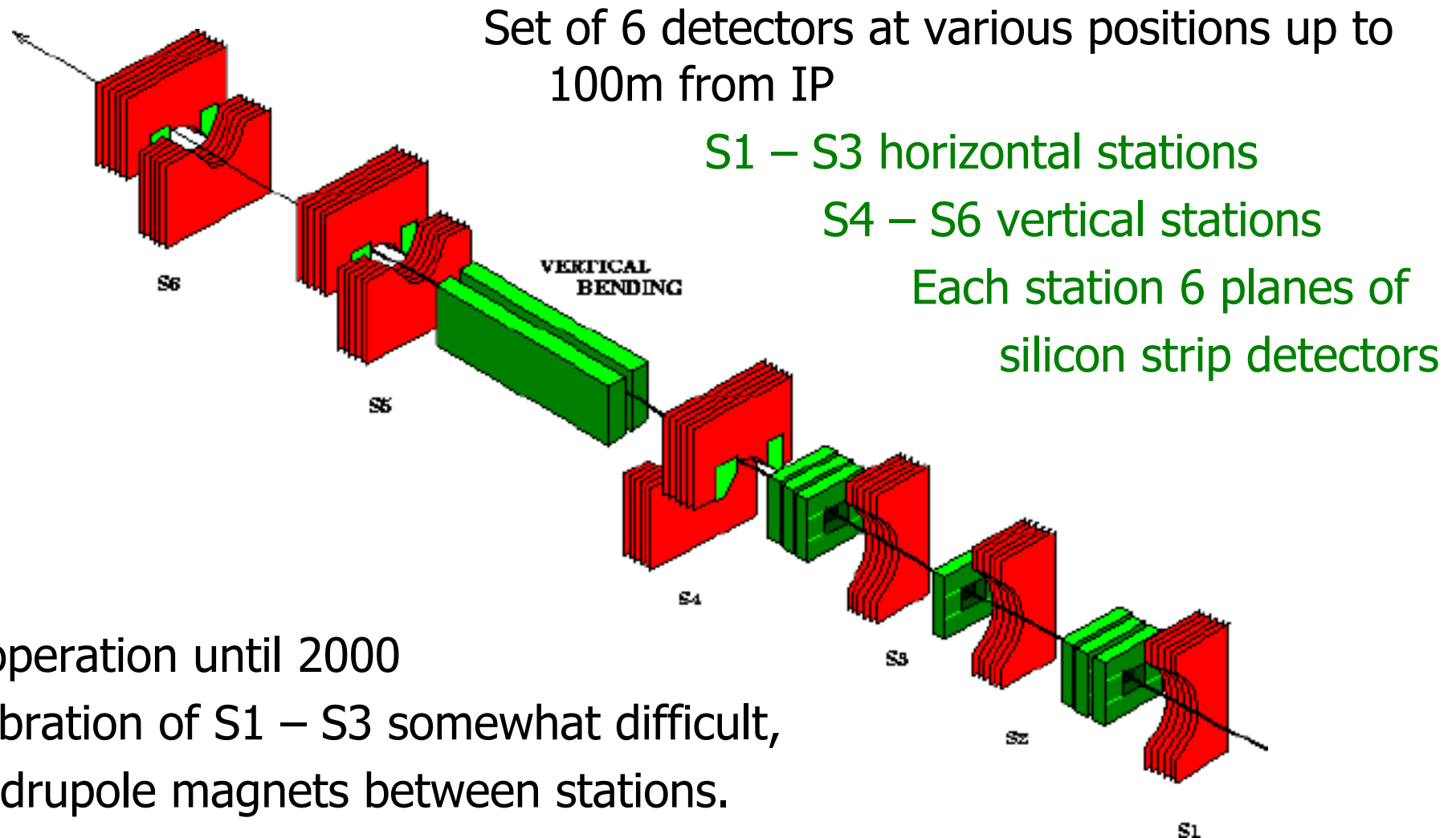

Set of 6 detectors at various positions up to 100m from IP

S1 – S3 horizontal stations

S4 – S6 vertical stations

Each station 6 planes of silicon strip detectors

In operation until 2000

Calibration of S1 – S3 somewhat difficult, quadrupole magnets between stations.

Operation: some interference with HERA B wire target

# H1 Forward Proton Spectrometer

2 horizontal and 2 vertical stations

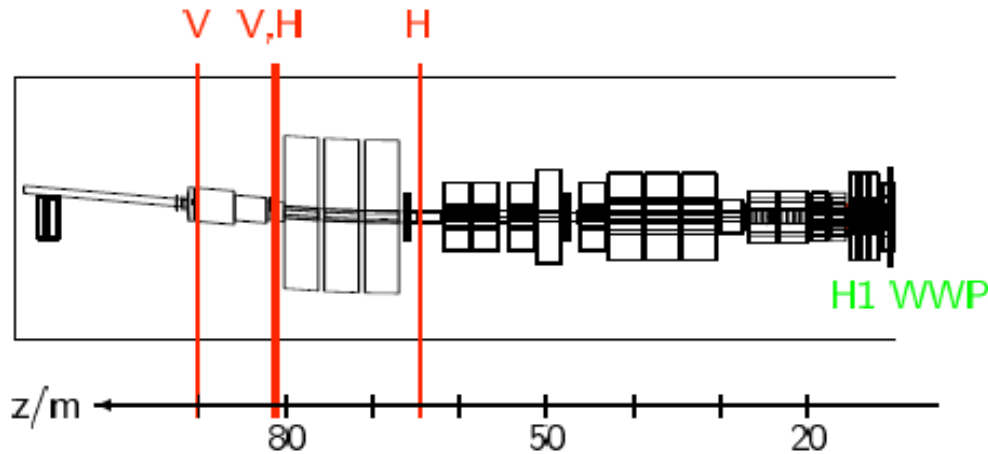

5 layers of scintillating fibers  
1mm diameter

Acceptance for  $E'_p = 580 - 740$  GeV

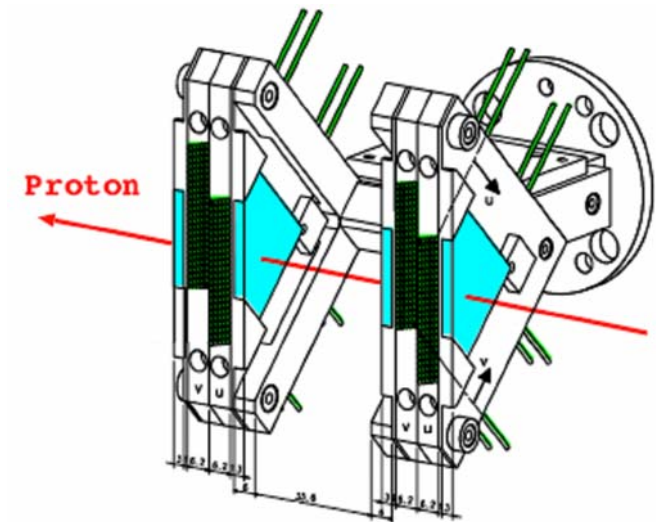
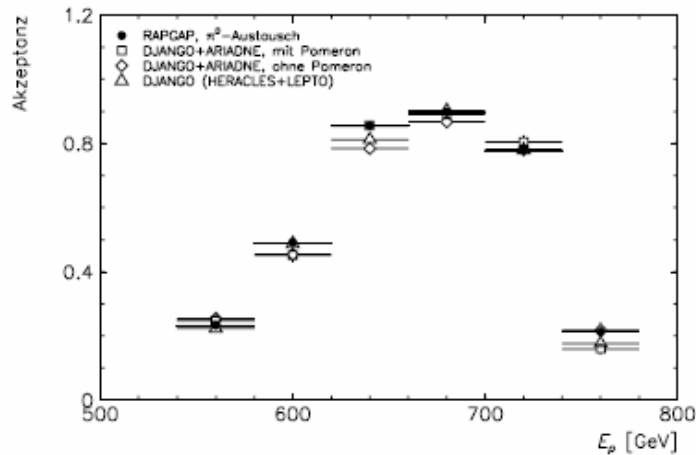

# H1 Very Forward Proton Spectrometer

Two stations at 218 and 222m from IP. In cold section of machine (cold bypass).

Purpose

- Tagging of diffractive proton with
  - Large acceptance in  $x_p$
  - Full  $t$  coverage
- Complementary to FPS
  - Small acceptance in larger  $x$  range
  - Limited  $t$ -acceptance

Fiber detector

Data taking 2005-2007

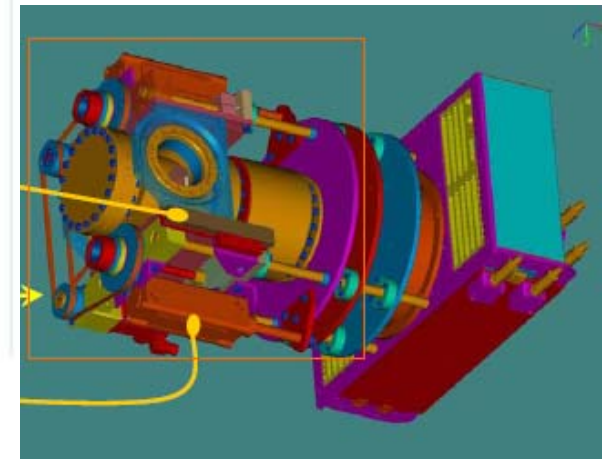
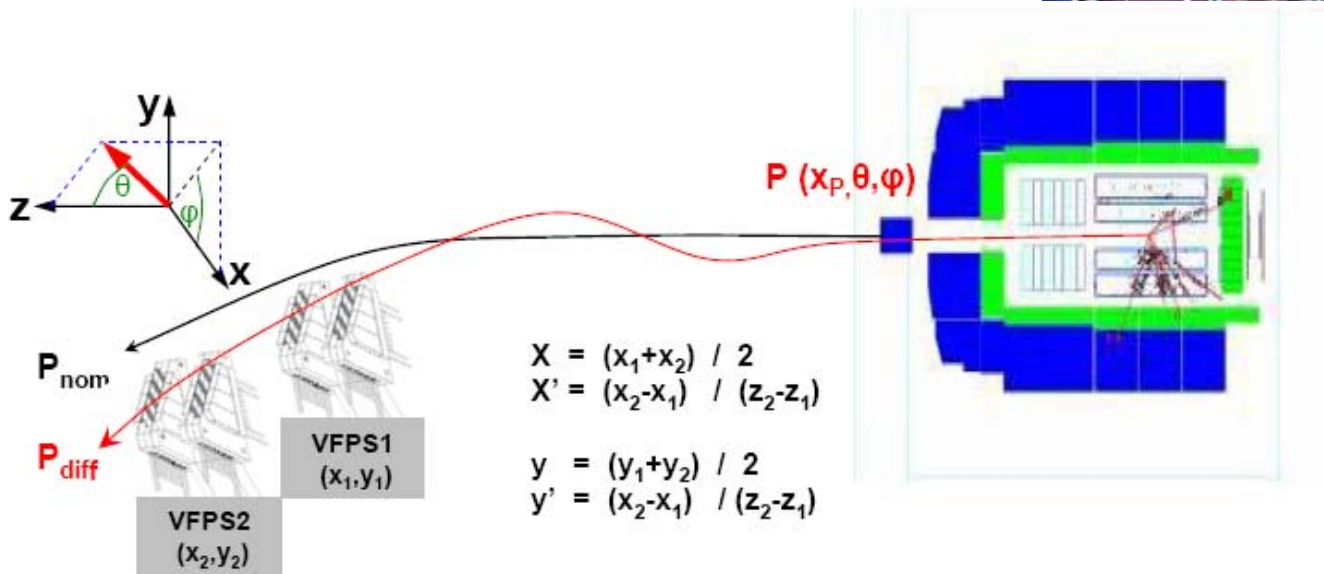



# Conclusions - Lessons

---

## HERA I IR

- Lower luminosity
- No machine magnets inside central detector volume
  - Detector: good forward and rear acceptance (hole  $< 1^\circ$ ,  $\eta \sim 4.9$ )
- No serious (background) problems.

## HERA II IR

- Pushed for higher luminosity
- Challenging design
  - Synchrotron radiation, no upstream collimators close to IP
  - Beam steering very critical
  - Access to central beam pipe (masks, cooling, flanges, BMPs,...) required a few month shutdown
- Forward/rear detector acceptance limited (hole  $\sim 3^\circ$ ,  $\eta \sim 3.8$ )



# Conclusions - Lessons

---

## HERA II IR

- Challenging design, continued
  - Several vacuum leaks due to constraint design, orbit movements and beam losses
  - Slow conditioning and vacuum improvement, almost continuous operation
  - Beam orbit control
    - Active safety system:
      - Temperature, vacuum interlocks
      - Beam loss, high background rates
      - ⇒ Beam abort
  - Magnet alignment and position stability

Very close cooperation between machine and experiments during design and operation absolutely essential.





# General Remarks on Interaction Region

---

Design of IR crucially depends on physics program

- Always compromise between high luminosity and
  - (Final magnets close to IP, inside detector volume)
- full detector acceptance
  - (Tracking and calorimetry down to very low angles)

Very small emittance electron beam (LINAC) has several advantages

- Final magnets not as close to IP
- Still high luminosity
- Good detector acceptance
- Potentially less background problems

If good calorimeter acceptance required by physics program:

- First machine magnet must be behind calorimeter
- First machine magnets at about 5m from IP. Not closer.